



Photocoupler
Product Data Sheet
LTV-224

Spec No. :DS70-2010-0080
Effective Date: 12/03/2024
Revision: B

LITE-ON DCC

RELEASE

BNS-OD-FC001/A4

Photocoupler LTV-2X4-G series

1. DESCRIPTION

1.1 Features

- Current transfer ratio (CTR) : MIN. 20% at $I_F = \pm 1\text{mA}$, $V_{CE} = 5\text{V}$, $T_a = 25^\circ\text{C}$
- High input-output isolation voltage. ($V_{iso} = 3,750\text{Vrms}$)
- Employs double transfer mold technology
- ESD pass HBM 8000V / MM2000V
- Safety approval:
 - UL 1577
 - VDE DIN EN60747-5-5 (VDE 0884-5) ,
 - CSA CA5A
 - DEMKO/FIMKO/SEMKO/NEMKO
 - CQC GB 4943.1-2022
- RoHS Compliance: All materials be used in device are followed EU RoHS directive (No. 2011/65/EU, and 2015/863).
- MSL class1
- Halogen free

1.2 Applications

- Hybrid substrates that require high density mounting.
- Programmable controllers
- System appliances, measuring instruments

Photocoupler LTV-2X4-G series

2. PACKAGE DIMENSIONS

2.1 LTV-214-G

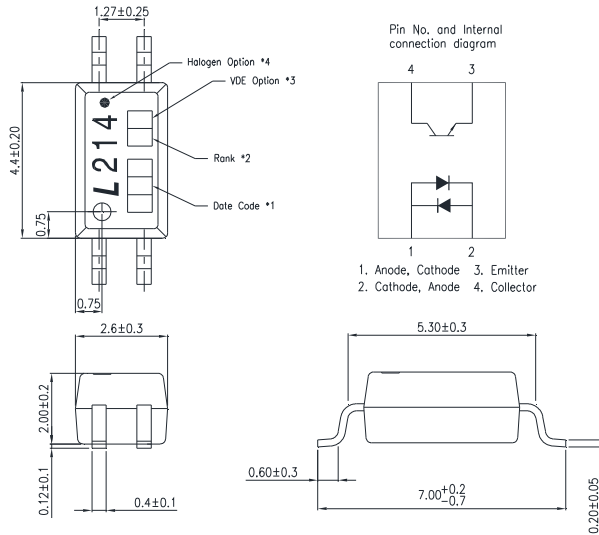

2.2 LTV-224-G

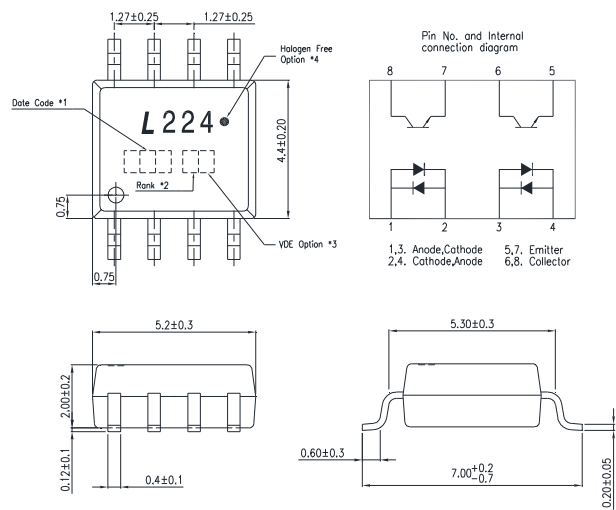

Notes :

1. 1-digit year code, Example : 2010 = A
2-digit work week ranging from '01' to '52' (01, 03...China -TJ, 02,04...China -CZ)
2. Rank shall be or shall not be marked.
3. VDE mark only appears on devices ordered "V" option.
4. "●" for halogen free option.

*All dimensions in millimeters.

Photocoupler LTV-2X4-G series

2.3 LTV-244-G

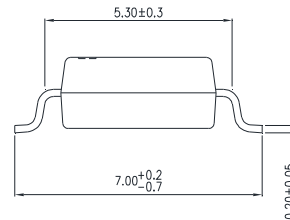
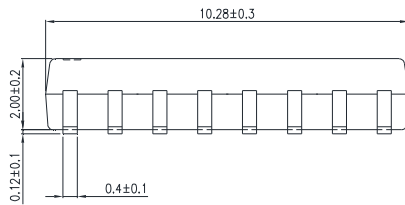
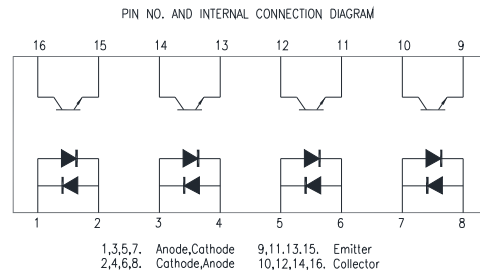
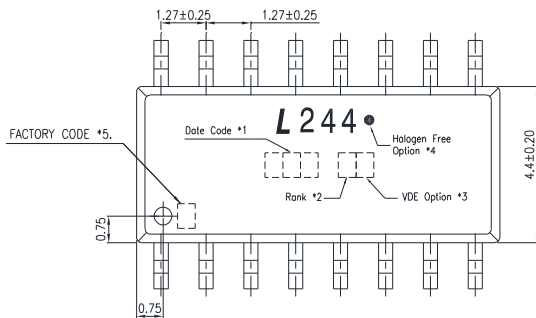

Notes :

- 1-digit year code, Example : 2010 = A
2-digit work week ranging from '01' to '52' (01, 03...China -TJ, 02,04...China -CZ)
- Rank shall be or shall not be marked.
- VDE mark only appears on devices ordered "V" option.
- "●" for halogen free option.
- Factory identification mark shall be marked (Y: Thailand, No marking: China -TJ, China -CZ)

*All dimensions in millimeters.

Photocoupler LTV-2X4-G series

3. TAPING DIMENSIONS

3.1 LTV-214-G

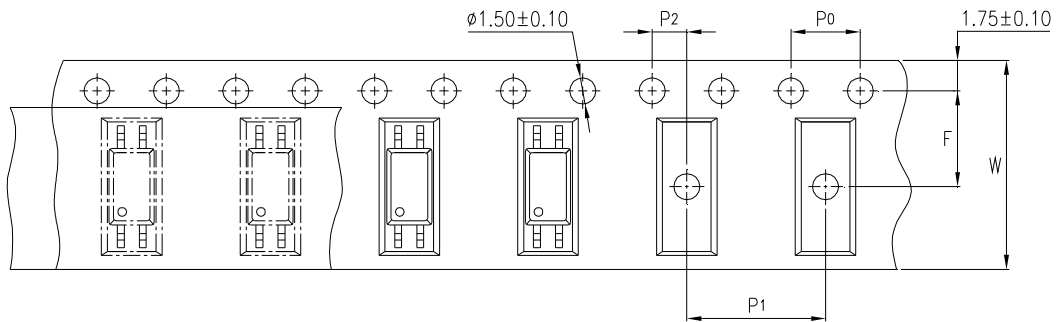

3.2 LTV-214-TP1-G

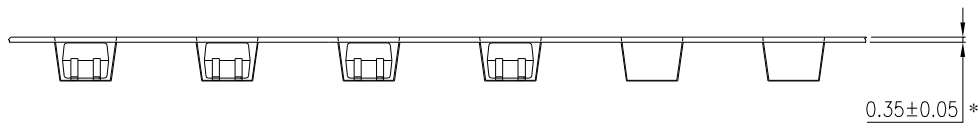
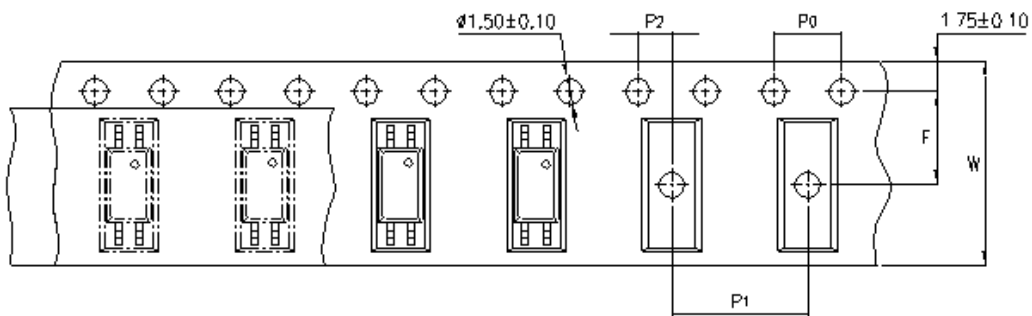

Description	Symbol	Dimension in mm (inch)
Tape wide	W	12±0.3 (0.47)
Pitch of sprocket holes	P ₀	4±0.1 (0.15)
Distance of compartment	F	5.5±0.1 (0.217)
	P ₂	2±0.1 (0.079)
Distance of compartment to compartment	P ₁	8±0.1 (0.315)

**Photocoupler
LTV-2X4-G series**

3.3 LTV-224-G

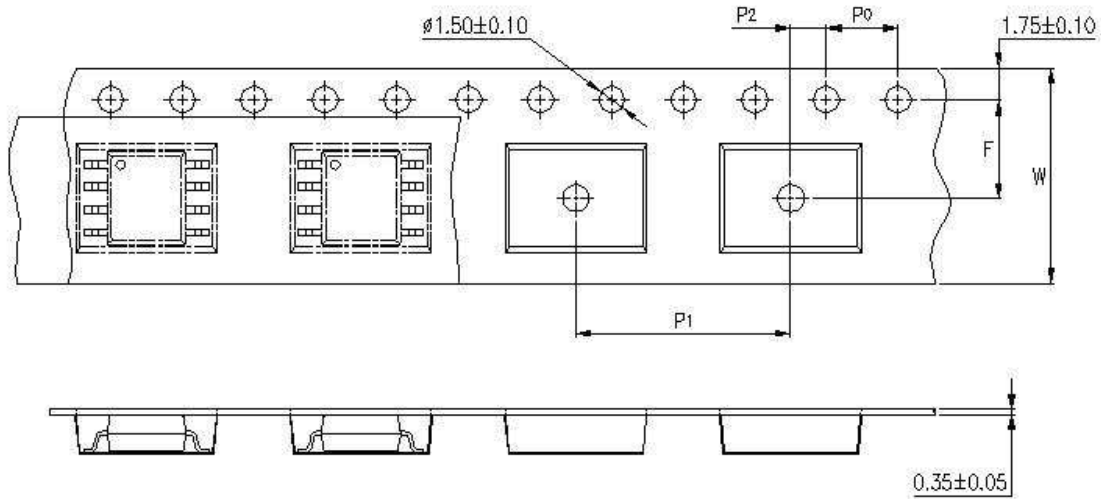

Description	Symbol	Dimension in mm (inch)
Tape wide	W	12±0.3 (0.47)
Pitch of sprocket holes	P ₀	4±0.1 (0.15)
Distance of compartment	F	5.5±0.1 (0.217)
	P ₂	2±0.1 (0.079)
Distance of compartment to compartment	P ₁	12±0.1 (0.472)

Photocoupler
LTV-2X4-G series

3.4 LTV-244-G

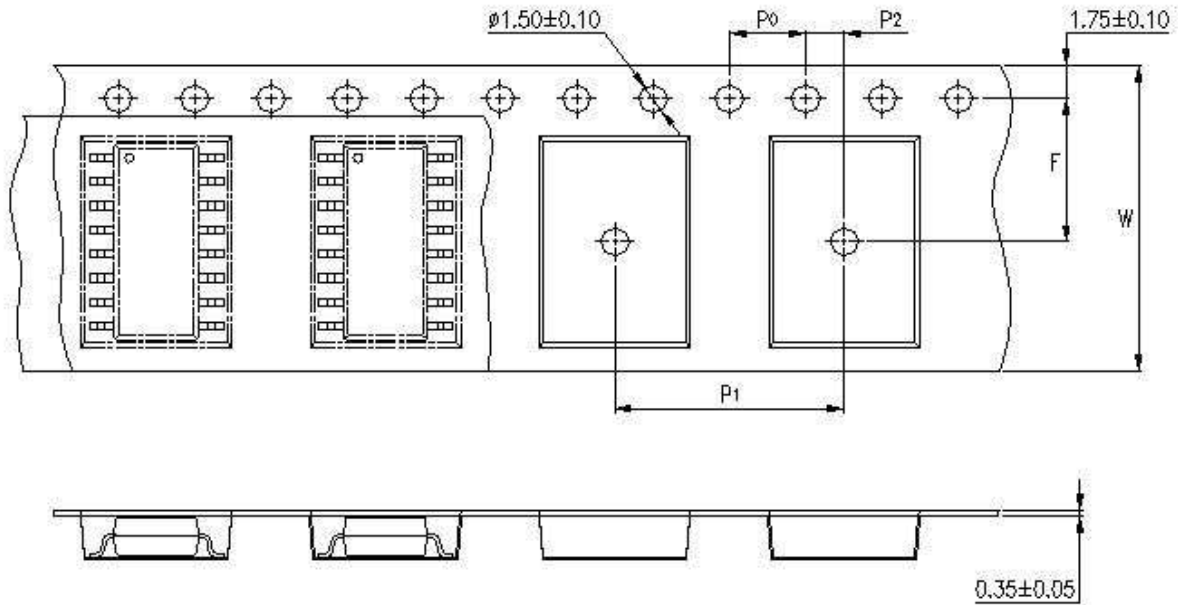

Description	Symbol	Dimension in mm (inch)
Tape wide	W	16±0.3 (0.63)
Pitch of sprocket holes	P ₀	4±0.1 (0.15)
Distance of compartment	F	7.5±0.1 (0.295)
	P ₂	2±0.1 (0.079)
Distance of compartment to compartment	P ₁	12±0.1 (0.472)

3.5 Quantities per Reel

Package Type	LTV-214-G series	LTV-224-G series	LTV-244-G series
Quantities (pcs)	3000	2000	2000

Photocoupler LTV-2X4-G series

4. RATING AND CHARACTERISTICS

4.1 Absolute Maximum Ratings at Ta=25°C

	Parameter	Symbol	Rating		Unit
			214	224 244	
Input	Forward Current	I_F	± 50		mA
	Power Dissipation	P	65		mW
Output	Collector - Emitter Voltage	V_{CEO}	80		V
	Emitter - Collector Voltage	V_{ECO}	7		V
	Collector Current	I_C	50		mA
	Collector Power Dissipation	P_C	150	100	mW
	Total Power Dissipation	P_{tot}	200	170	mW
1.	Isolation Voltage	V_{iso}	3750		V_{rms}
	Operating Temperature	T_{opr}	-55 ~ +110		°C
	Storage Temperature	T_{stg}	-55 ~ +150		°C
2.	Soldering Temperature	T_{sol}	260		°C

1. AC For 1 Minute, R.H. = 40 ~ 60%

Isolation voltage shall be measured using the following method.

- (1) Short between anode and cathode on the primary side and between collector and emitter on the secondary side.
- (2) The isolation voltage tester with zero-cross circuit shall be used.
- (3) The waveform of applied voltage shall be a sine wave.

2. For 10 Seconds

Photocoupler LTV-2X4-G series

4.2 ELECTRICAL OPTICAL CHARACTERISTICS at Ta=25°C

Parameter		Symbol	Min.	Typ.	Max.	Unit	Test Condition
Input	Forward Voltage	V_F	—	1.2	1.4	V	$I_F = \pm 20\text{mA}$
	Terminal Capacitance	C_t	—	60	—	pF	$V=0, f=1\text{KHz}$
Output	Collector Dark Current	I_{CEO}	—	—	100	nA	$V_{CE}=20\text{V}, I_F=0$
	Collector-Emitter Breakdown Voltage	BV_{CEO}	80	—	—	V	$I_C=0.1\text{mA}, I_F=0$
	Emitter-Collector Breakdown Voltage	BV_{ECO}	7	—	—	V	$I_E=10\mu\text{A}, I_F=0$
TRANSFER CHARACTERISTICS	Collector-Emitter Saturation Voltage	$V_{CE(sat)}$	—	—	0.4	V	$I_F \pm 8\text{mA}, I_C=2.4\text{mA}$
	Isolation Resistance	R_{iso}	5×10^{10}	1×10^{11}	—	Ω	DC500V, 40 ~ 60% R.H.
	Floating Capacitance	C_f	—	0.8	1	pF	$V=0, f=1\text{MHz}$
	Response Time (Rise)	t_r	—	3	18	μs	$V_{CC}=5\text{V}, I_C=2\text{mA}$
	Response Time (Fall)	t_f	—	4	18	μs	$R_L=100\Omega, f=100\text{Hz}$

Photocoupler LTV-2X4-G series

5. RANK TABLE OF CURRENT TRANSFER RATIO

Model No.	CTR Rank	Min	Max	Condition
LTV-214-G	0 or No mark	20	400	$I_F = \pm 1\text{mA}$, $V_{CE} = 5\text{V}$, $T_a = 25^\circ\text{C}$
	A	50	250	
	AK	100	200	
	B	100	400	$I_F = \pm 5\text{mA}$, $V_{CE} = 5\text{V}$, $T_a = 25^\circ\text{C}$
	GR	100	300	
	GB	100	400	
LTV-224-G LTV-244-G	0 or No mark	20	400	$I_F = \pm 1\text{mA}$, $V_{CE} = 5\text{V}$, $T_a = 25^\circ\text{C}$
	A5	100	300	
	GB	100	400	$I_F = \pm 5\text{mA}$, $V_{CE} = 5\text{V}$, $T_a = 25^\circ\text{C}$

$$1. \text{ CTR} = \frac{I_C}{I_F} \times 100\%$$

Photocoupler LTV-2X4-G series

6. CHARACTERISTICS CURVES

Figure 1. Collector Power Dissipation vs. Ambient Temperature

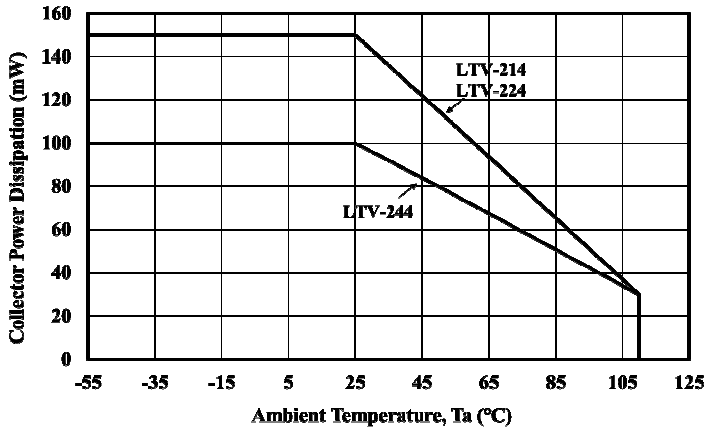

Figure 2. Forward Current vs. Ambient Temperature

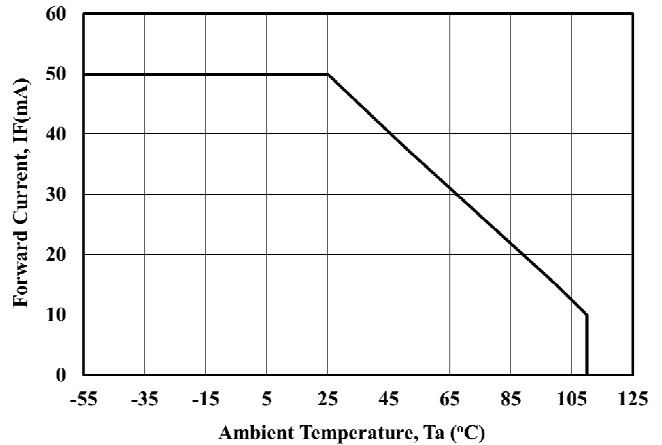

Figure 3. Forward Current vs. Forward Voltage

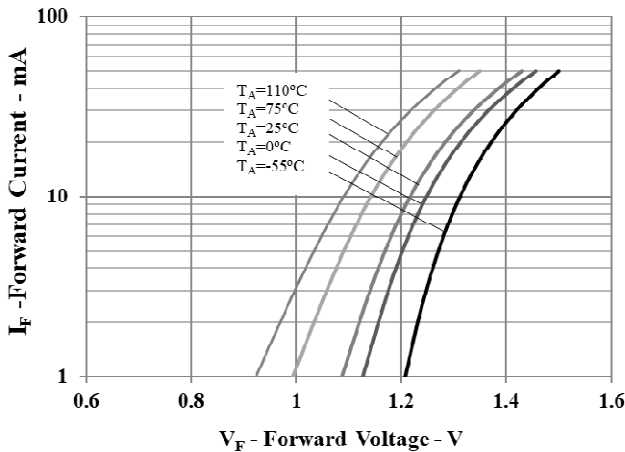

Figure 4. Forward Voltage Temperature Coefficient vs. Forward Current

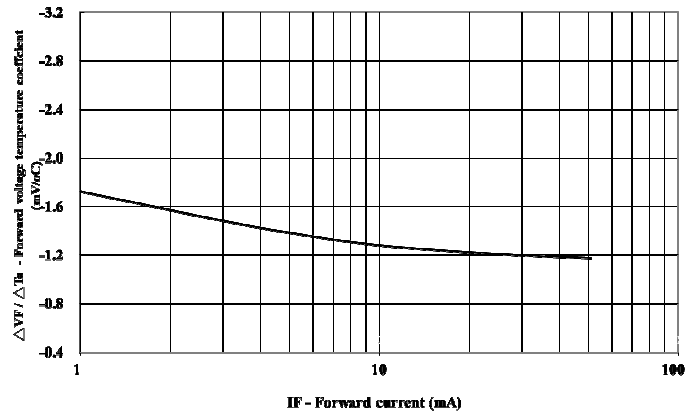

Figure 5. Pulse Forward Current vs. Duty Cycle Ratio

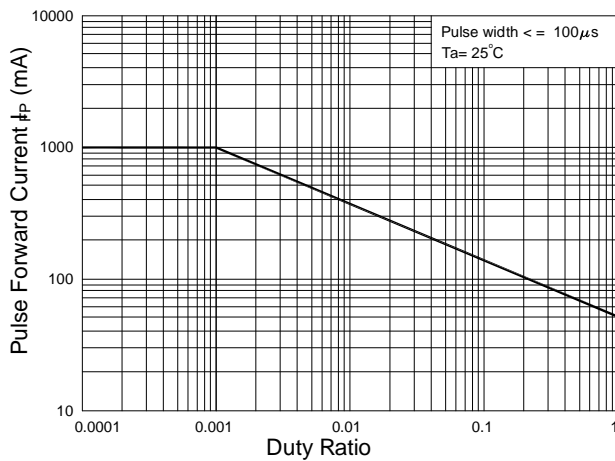
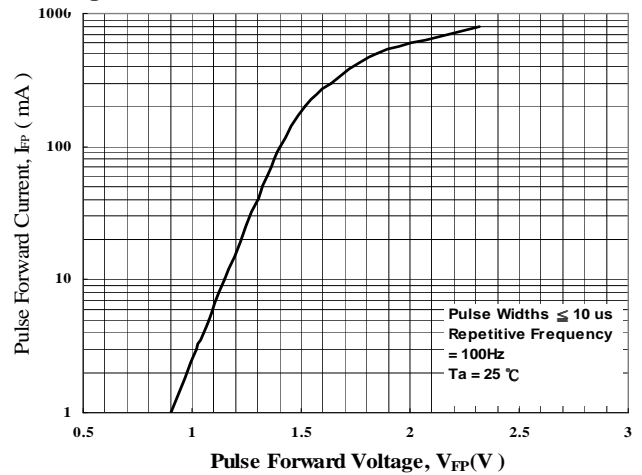

Figure 6. Pulse Forward Current vs. Pulse Forward



Photocoupler LTV-2X4-G series

Figure 7. Collector Current vs. Small Collector-Emitter

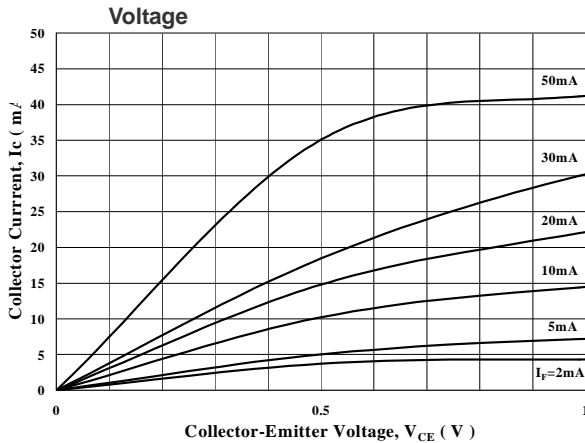

Figure 8. Collector Current vs. Collector-Emitter

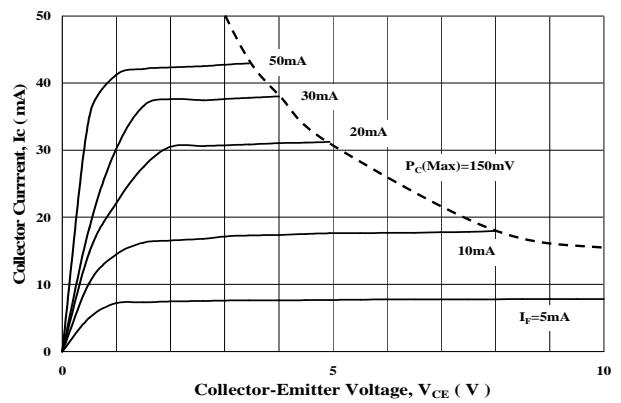

Figure 9. Normalized Collector Current vs. Forward

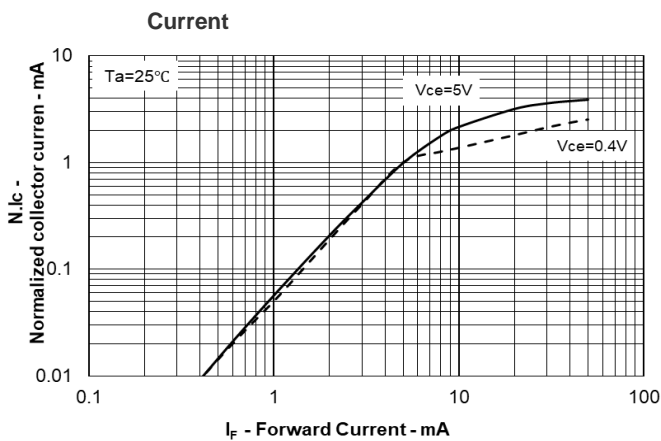

Figure 10. Normalized Current Transfer Ratio

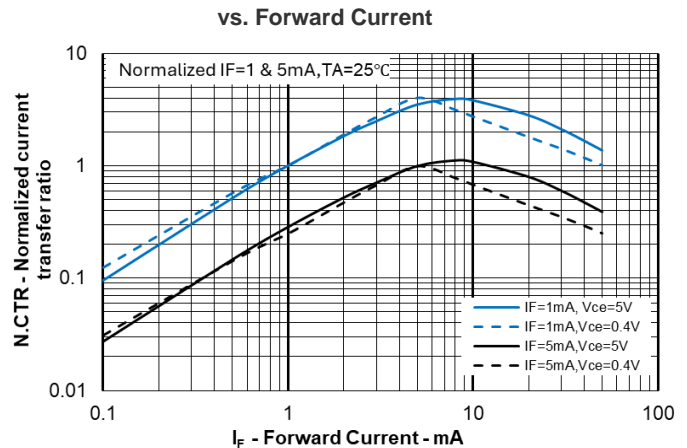

Figure 11. Normalized Current Transfer Ratio

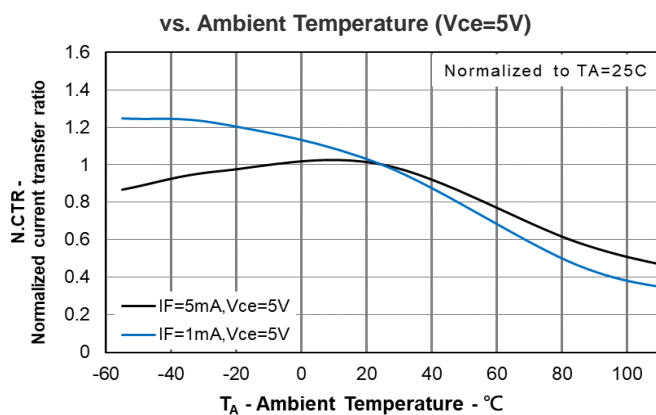
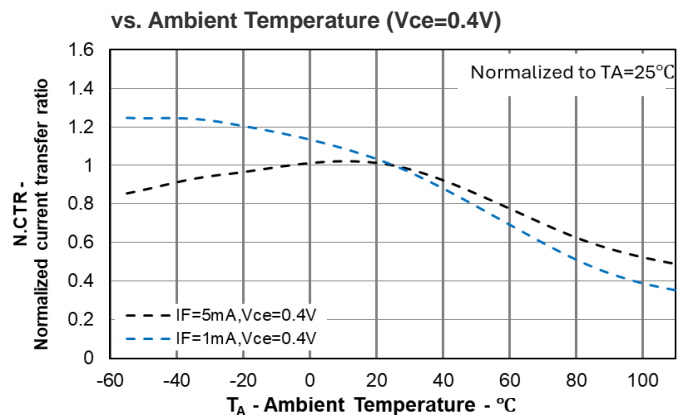

Figure 12. Normalized Current Transfer Ratio



Note: CTR value will decay under high temperature and low current, it is necessary to consider the decay rate by CTR-IF & CTR-TA curve when designing. IF is also recommended to use over 1mA.

Photocoupler LTV-2X4-G series

Figure 13. Collector Dark Current vs. Ambient

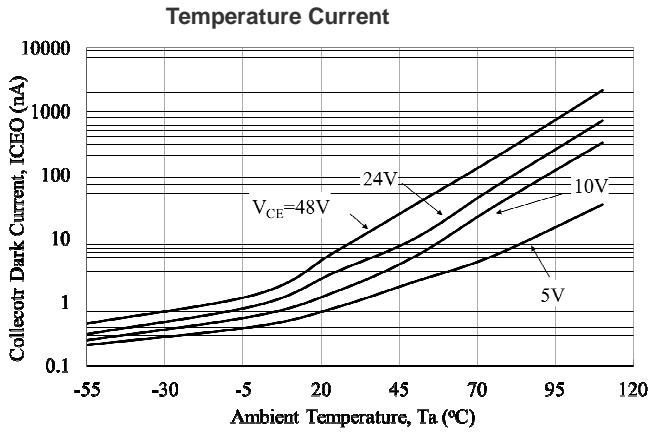

Figure 15. Switching Time vs. Load Resistance

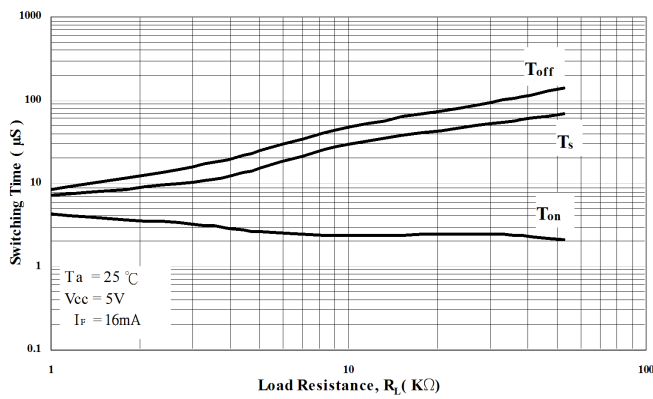

Figure 17. Frequency Response

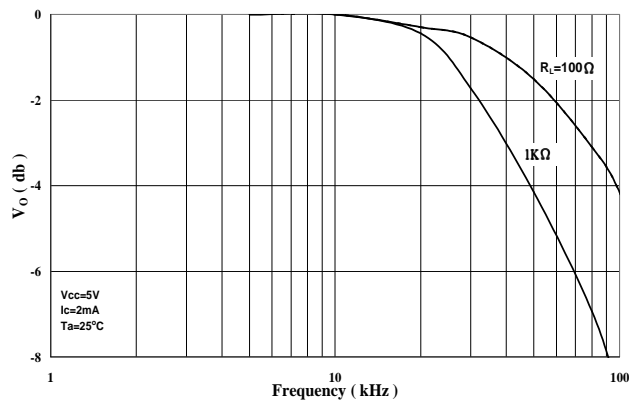

Figure 14. Collector-Emitter Saturation Voltage vs.

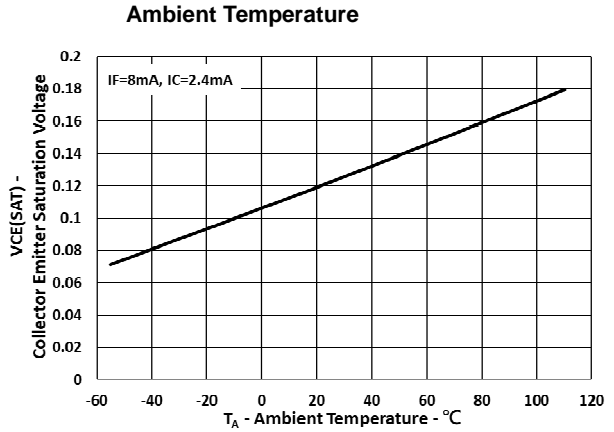
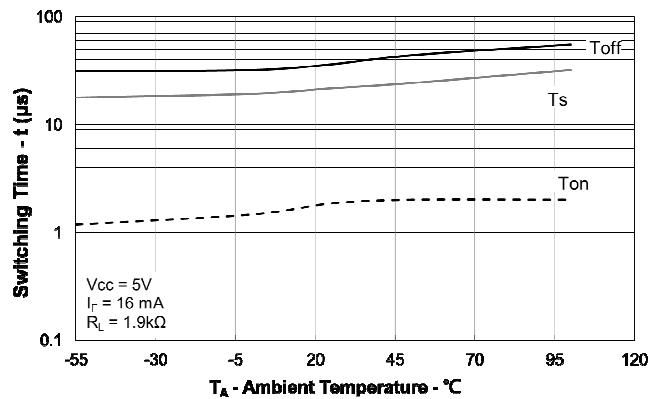

Figure 16. Switching Time vs. Ambient Temperature



Note : The above characteristic curves are presented for reference only and not guaranteed by production test, unless otherwise noted.

**Photocoupler
LTV-2X4-G series**

7. SWITCHING TIME TEST CIRCUIT

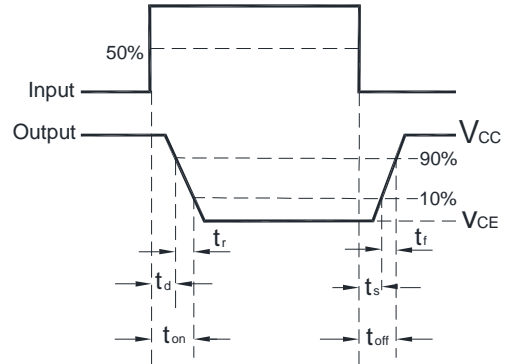
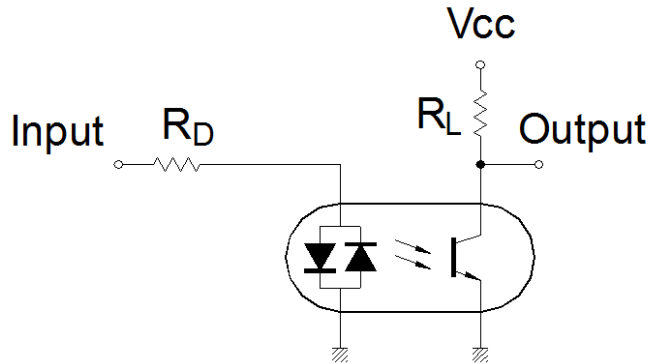

Photocoupler LTV-2X4-G series

8. TEMPERATURE PROFILE OF SOLDERING

8.1 IR Reflow soldering (JEDEC-STD-020C compliant)

One time soldering reflow is recommended within the condition of temperature and time profile shown below. Do not solder more than three times.

Profile item	Conditions
Preheat	
- Temperature Min (T_{Smin})	150°C
- Temperature Max (T_{Smax})	200°C
- Time (min to max) (ts)	90±30 sec
Soldering zone	
- Temperature (T_L)	217°C
- Time (t_L)	60 ~ 100 sec
Peak Temperature (T_P)	260°C
Ramp-up rate	3°C / sec max.
Ramp-down rate	3~6°C / sec

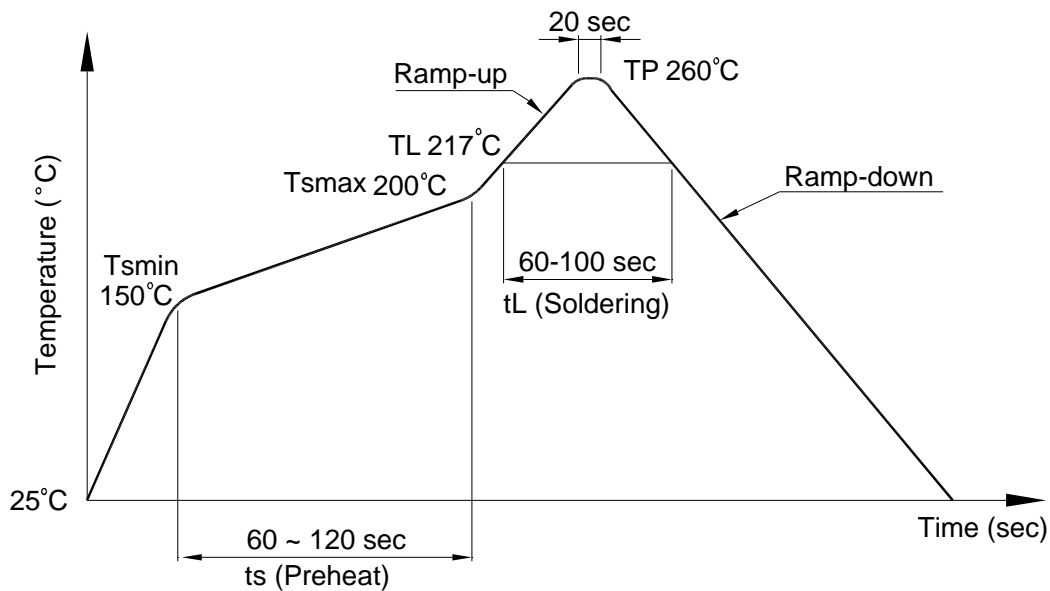

Photocoupler LTV-2X4-G series

8.2 Wave soldering (JEDEC22A111 compliant)

One time soldering is recommended within the condition of temperature.

Temperature: $260 \pm 0 / -5^{\circ}\text{C}$

Time: 10 sec.

Preheat temperature: 25 to 140°C

Preheat time: 30 to 80 sec.

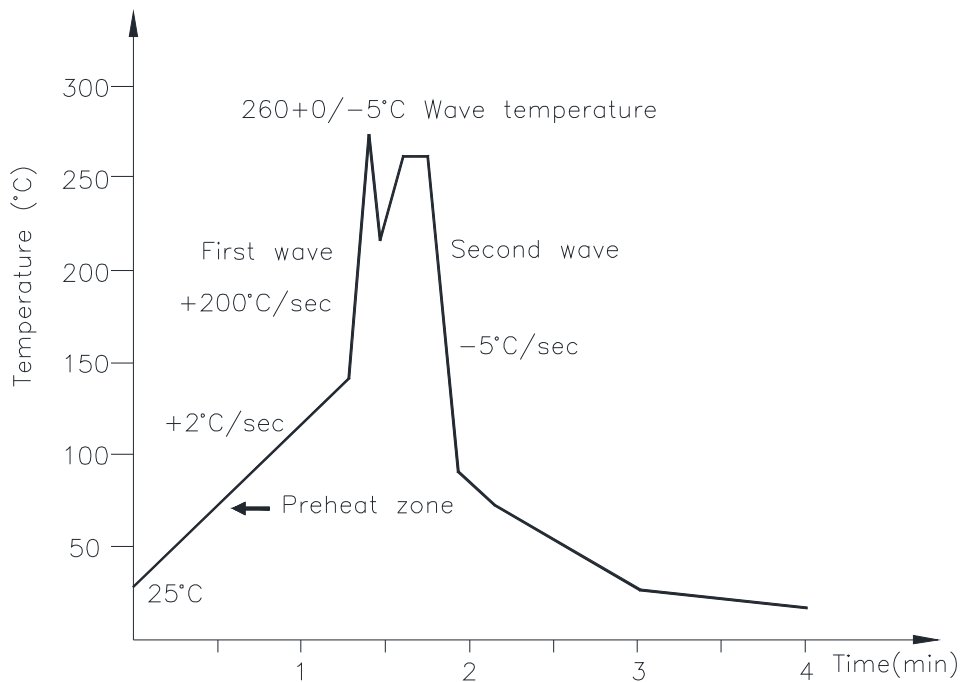

8.3 Hand soldering by soldering iron

Allow single lead soldering in every single process. One time soldering is recommended.

Temperature: $380 \pm 0 / -5^{\circ}\text{C}$

Time: 3 sec max.

**Photocoupler
LTV-2X4-G series**

9. RECOMMENDED FOOT PRINT PATTERNS (MOUNT PAD)

Unit: mm

9.1 LTV-214-G

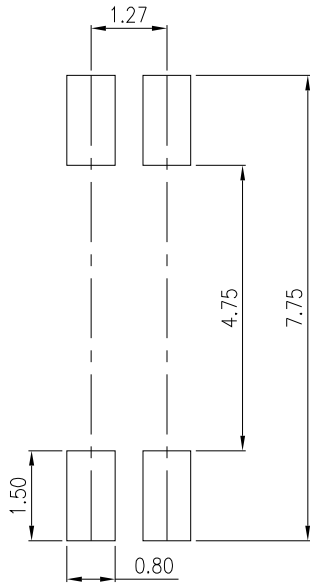

9.2 LTV-224-G

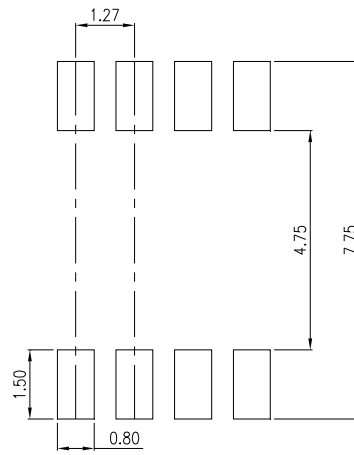

9.3 LTV-244-G

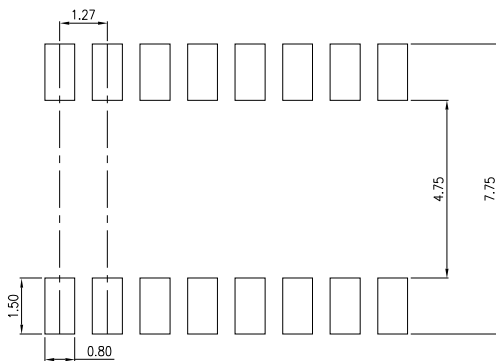

**Photocoupler
LTV-2X4-G series**

10. NAMING RULE

LTV-2X4-(1)-(2)-G-(4)

DEVICE PART NUMBER

(1) TAPING TYPE (TP1 or no suffix)

Please refer to orientation of taping on Page 3-5

(2) CTR RANK

Please refer to the CTR table on Page 8

(3) Halogen free option

(4) Customer code option

Example : LTV-214-TP1-A-G

LTV2X4(1)(2)-V-G-(4)

DEVICE PART NUMBER

(1) TAPING TYPE (TP1 or no suffix)

Please refer to orientation of taping on Page 3-5

(2) CTR RANK

Please refer to the CTR table on Page 8

(3) VDE order option

(4) Halogen free option

(5) Customer code option

Example : LTV214TP1A-V-G

11. NOTES

- LiteOn is continually improving the quality, reliability, function or design and LiteOn reserves the right to make changes without further notices.
- The products shown in this publication are designed for the general use in electronic applications such as office automation equipment, communications devices, audio/visual equipment, electrical application and instrumentation.
- For equipment/devices where high reliability or safety is required, such as space applications, nuclear power control equipment, medical equipment, etc, please contact our sales representatives.
- When requiring a device for any "specific" application, please contact our sales in advice.
- If there are any questions about the contents of this publication, please contact us at your convenience.
- The contents described herein are subject to change without prior notice.
- Immerse unit's body in solder paste is not recommended.